



苏州市昆腾电子有限公司  
SUZHOU CITY KUNTENG ELECTRONIC CO., LTD



# 用户手册

User Manual

---

KT-LCD1 eBike Special Meter

## Contents

Preface.....	3
Outlook and Size.....	3
Meter Dimension.....	3
Main Material and Color.....	3
Wiring Schematic.....	3
Installation Instruction.....	3
Function Overview.....	4
Display Content.....	4
Normal Operation.....	5
On/Off.....	5
Display Interface.....	5
PAS Ratio (or Handlebar) Gear Switch.....	6
Push Function.....	7
Cruise Function.....	7
Turn On/Off Backlight.....	7
Battery Capacity Indicator.....	8
Single Data Clearing.....	8
Total Trip Time and Distance Display.....	9
Single Maximum Speed and Average Speed Display.....	9
Error Code Display.....	9
User Project Setting.....	10
General Project Setting.....	10
Maximum Trip Speed.....	10
Wheel Diameter.....	11
Metric and Imperial Units.....	12
Exit General Project Setting.....	12
P Parameter Setting.....	13

P1 Motor Characteristic Parameter Setting Mode .....	13
P2 Wheel Speed Pulse Signal Setting Mode .....	13
P3 Power Assist Control Mode .....	14
P4 Handlebar Startup Mode .....	15
P5 Power Monitoring Mode .....	15
Exit P Parameter Setting .....	16
User Setting Note .....	16
Version Information.....	16

## Preface

The illustrated manual will help you understand and be familiar with the meter function, guiding you on how to operate the meter, how to set the project parameters, how to achieve the best match of the three as motor, controller and meter to improve electronic control performance of the electric motor. This manual covers installation, operation, parameter setting of the meter and how to use it properly, which help you resolve the problems appeared in practical use.

## Outlook and Size

### ○ Meter Dimension

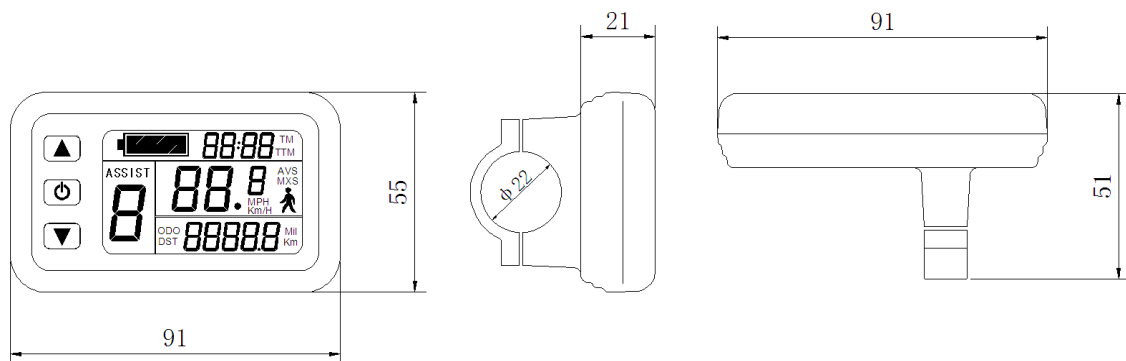

### ○ Main Material and Color

PC material is mainly used for KT-LCD1 meter housing, and the housing color is dark gray or white.

### ○ Wiring Schematic

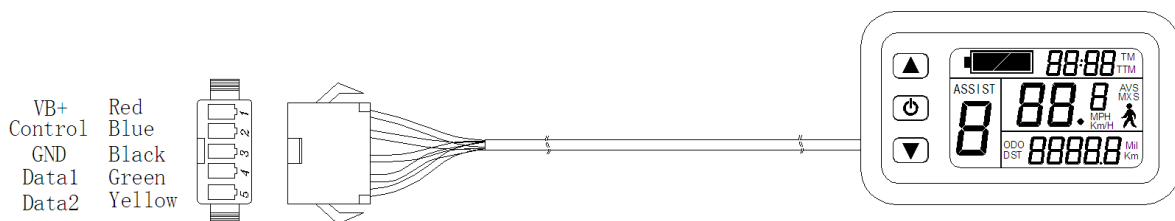

## Installation Instruction

The meter body are mounted on the handlebars of the electric vehicle, adjusting perspective. In the case that the vehicle is power off, the meter connectors are in plug connection to corresponding controller connectors. Turn on the power, electric vehicle and meter will be under normal operation, the meter installation is finished. The protection film on meter display panel should be torn.



Physical installation icon

## Function Overview

KT-LCD1 meter provide you with a variety of functions such as vehicle controls and vehicle status digitized displays to meet the trip demands.

- ◇ Trip time display (with displays of a single trip time (TM) and total trip time (TTM));
- ◇ Trip speed display (with displays of real-time speed (Km/H or MPH) and a single maximum speed (MXS) and a single average speed (AVS));
- ◇ Trip distance display (with displays of a single trip distance (DST) and total trip distance (ODO));
- ◇ Power assistant ratio (or handlebar) gear (**ASSIST**) switch;
- ◇ 6Km/H power assistant push (🚶) function;
- ◇ Cruise function (can be customized for clients);
- ◇ Battery capacity indicator (🔋);
- ◇ Turn on backlighting and lights;
- ◇ Data clearing;
- ◇ Fault code display;
- ◇ User parameter setting;
- ◇ 24V, 36V supply voltage can automatic identification and be compatible.

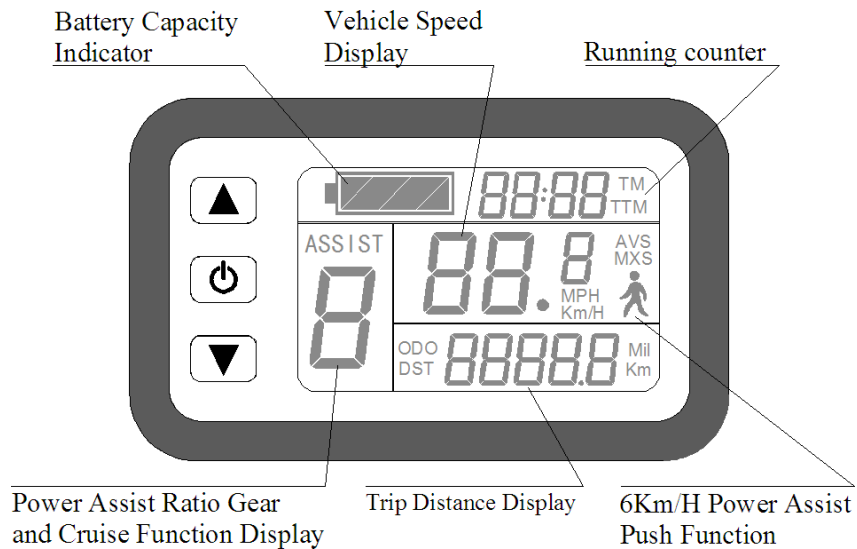

## Display Content

The display content is shown as follow.



## Normal Operation

### ○ On/Off

Hold  button (SW) long, the meter is powered on and into normal operation, and it provides the controller with power supply. Under normal operating status, hold  button (SW) long, the meter is powered off, meanwhile to shutdown the power supply of controllers. **When the vehicle is stopped and without any button operation on the meter for five minutes, the meter will automatically shut down, and the power supply of the electric vehicle will be powered off.** In power off mode, the power consumption of the meter and controller is zero.

### ○ Display Interface

The meter is startup to enter display interface.

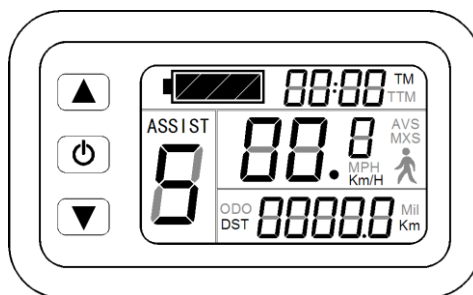

The followings are shown on interface.

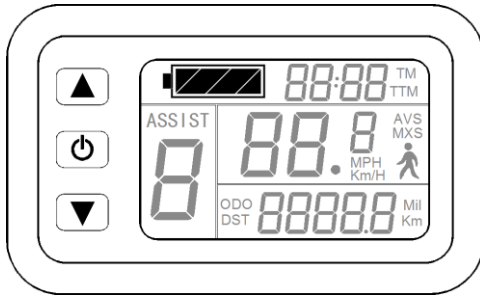

Battery Capacity Indicator

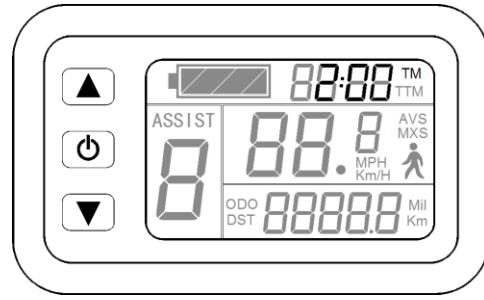

Single Trip Time (TM) Display

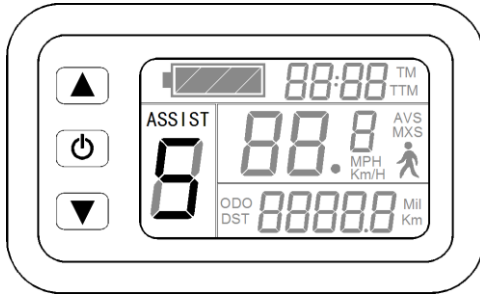

Power Assist Ratio Gear (ASSIST)

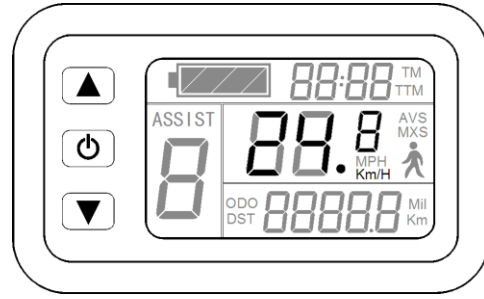

Real-time Trip Speed (Km/H)

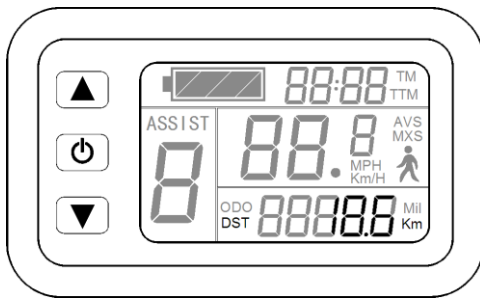

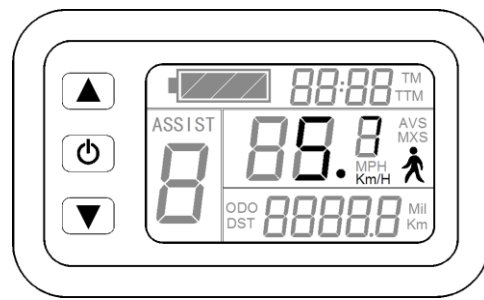

Single Trip Distance(DST)



6Km/H Power Assist Function

In display interface, if you hold  button (SW) long, the meter will be powered-off together with that of the controller.

○ PAS Ratio (or Handlebar) Gear Switch

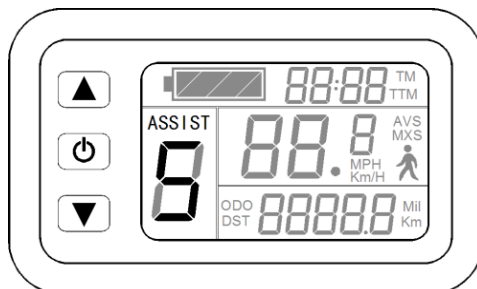

Under normal operation, hold  button (UP) or  button (DOWN) to switch the power assist ratio (or handlebar) gear (ASSIST), changing motor output power. Switching range is 1-5 gear (this can also be configured according to the customer requirements), gear 1 is for the lowest power, and gear 5 is for the highest power.



### PAS Ratio Gear Switch

At every startup, the meter will automatically restore gear (this can also be configured as required by users) when it was at last shut down. When the power assist ratio is gear 0 zero, there's no power assist function.

#### ○ Power Assistant Push Function

Users can use 6Km/H power assist function when pushing vehicles. Hold  button (**DOWN**), the meter assist function logo () flashes, the vehicle drives at the speed of no more than 6Km/h. Release  button (**DOWN**), the assist function will be revoked.

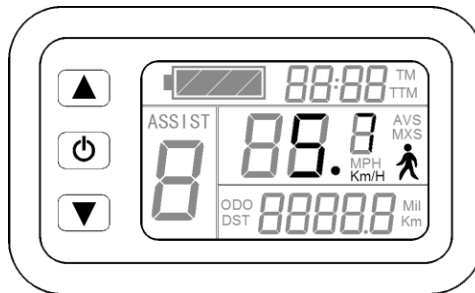

6Km/H power assistant push function

#### ○ Cruise Function(can be customized for clients)

hold  button (**DOWN**) long to enter the cruise status when the vehicle speed is more than 7 km/h, and the cruise function logo (C) lights. Brake or hold any button to revoke cruise function.

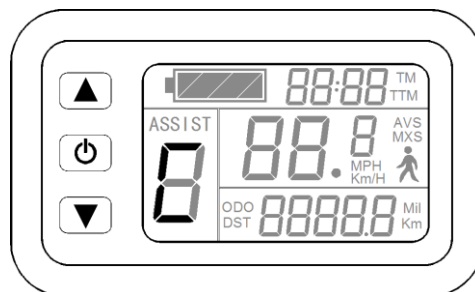

Cruise Function(C)

#### ○ Startup Backlights and Headlights

Hold  button (**UP**) long, the meter turns on the backlights as well as the vehicle headlights (the Controller should have headlights driving and output functions), hold



 button (**UP**) long again to turn off backlights and vehicle headlights.

○ **Battery Capacity Indicator**

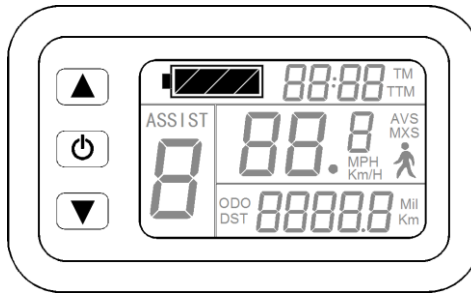

The meter can automatically identify 24V, 36V, 48V battery capacities when it is supporting use with the specified controller. When the battery capacity is over 70%, the four power displays of the meter are lit, when the battery capacities drop, the four power displays are off in order, when the power capacity is less than 15%, the four power displays are totally turned off.

When the controller is power off due to voltage shortage, the power display frame flashes, indicating the vehicle has been in voltage shortage and waiting for shutdown currently.



Battery capacity indicator

○ **Single Data Clearing**

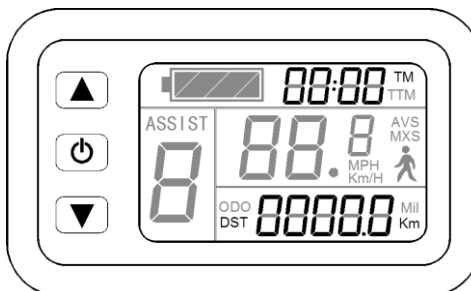

5 seconds after the meter is powered on, at display interface , hold both the  button (**UP**) and the  button (**DOWN**) simultaneously for about 2 seconds, the single trip time (TM) and single trip distance (DST) flicker, then hold  button (**SW**) shortly, the record contents of both will be cleared.



### Single data clearing display

Under the status of data flashing, if there were no operations on the data within 5 seconds, the meter will automatically return to display interface after 5 seconds, and the original record content will be saved.

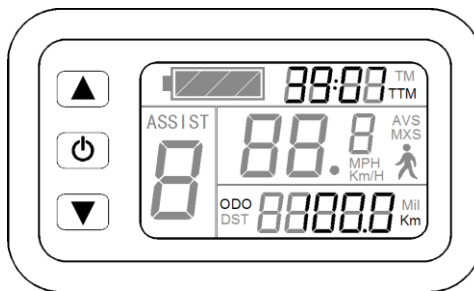

#### ○ Total Trip Time and Distance

At display interface, the hold  button (SW) shortly to display of total trip time (TTM) and total trip distance (ODO). Hold  button (SW) shortly again to return the display interface. **In the riding mode after 5 seconds, automatically returns to display interface.**



Total Trip Time (TTM) and Distance (ODO)

#### ○ Single Maximum Speed and Average Speed

In the display of total trip time and distance, hold  button (UP) or  button (DOWN) shortly to display of single maximum speed (MXS) and average speed (AVS). Hold  button (SW) shortly again to return the display interface. **In the riding mode after 5 seconds, automatically returns to display interface.**

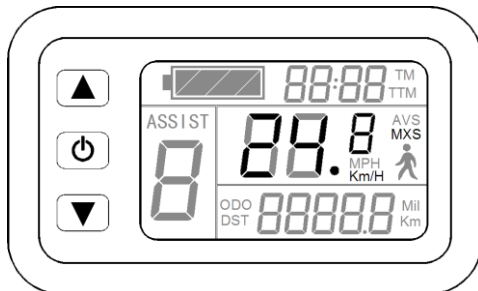

Single Maximum Speed (MXS)

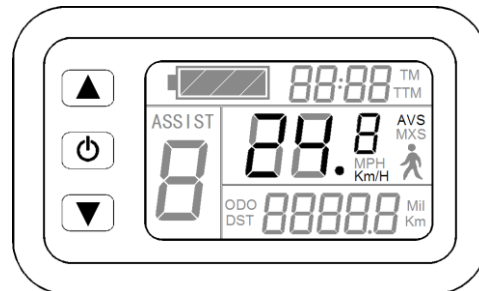

Single Average Speed (AVS)

#### ○ Error Code Display

When the electronic control system of the electric vehicle fails, and the meter will

automatically display (flicker) fault code. You can't exit the fault code display only the fault is removed.

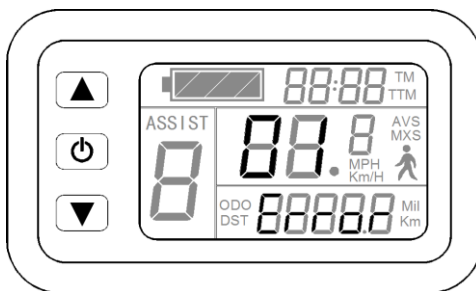

Error Code Display

Error Code & Definition Table:

Error Code	Definition
01__Error	Throttle Abnormality
03__Error	Motor Hall Signal Abnormality
04__Error	Torque sensor Signal Abnormality
05__Error	Axis speed sensor Abnormality(only applied to torque sensor )
06__Error	Motor or controller has short circuit Abnormality





### User Setting Project

KT-LCD1 meter user setting project:

- ◇ General project setting
- ◇ P parameter setting

### General Project Setting

#### ○ Maximum Trip Speed

Under power off status, hold  button long (SW), the meter is turned on. Within 5 seconds after boot-up, hold  button (UP) and  button (DOWN) simultaneously for about 2 seconds, the first is to enter the maximum riding speed setting interface, then the speed display column flashes. Hold  button shortly (UP) or  button (DOWN) in order to set the maximum riding speed value. **The default maximum riding speed value was 25Km/h.** When the speed of the electric vehicle exceeds the set value, the motor will be stopped driving.

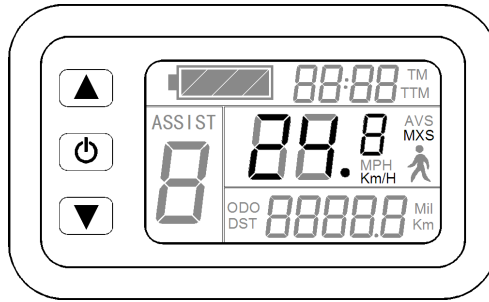



Setting interface of maximum trip speed

**Under the setting maximum riding speed interface, if there's no button operation on the meter for more than 1 minute, and then the meter will automatically return to display interface, and the original set values will be saved.**

After finishing the maximum riding speed setting, hold  button (SW) shortly to enter into the next setting.

#### ○ Wheel Diameter

After finishing the maximum riding speed setting, enter the wheel diameter setting interface, and then the wheel diameter display column flashes. Hold  button (UP) or  button (DOWN) to choose the corresponding wheel diameter specification to a selected vehicle. The selection range of wheel diameter specifications are 12 species such as 8,10,12,14,16,18,20,22,24,26,700c and 28 inches.

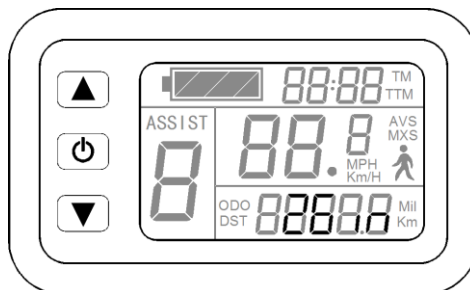



Setting Interface of Wheel Diameter

**Under the wheel diameter setting interface, if there's no button operation on the meter for more than 1 minute, and then the meter will automatically return to display interface, and the original set values will be saved.**

After finishing the wheel diameter setting, hold  button (SW) shortly to enter into the next setting.

### ○ Metric and Imperial Units

After finishing the wheel diameter setting, enter into the metric/imperial units setting interface, and then the speed and mileage unit flash. Hold  button (**UP**) or  button (**DOWN**) shortly to make sync selection of two metric/imperial units as speed, mileage.

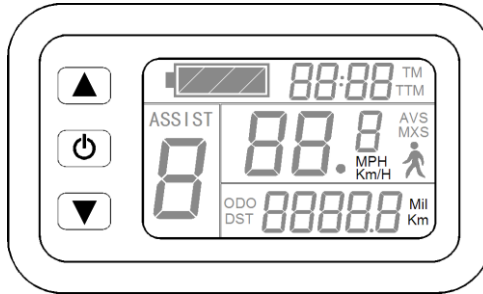



Setting Interface of Metric/Imperial Units

Definition Table of Metric/Imperial Units:

Display	Metric	Imperial
Riding speed	Km/H	MPH
Total distance	Km	Mil

**Under the metric/imperial units setting interface, if there's no button operation on the meter for more than 1 minute, and then the meter will automatically return to display interface, and the original set units will be saved.**



After finishing the metric/imperial units setting, hold  button (**SW**) shortly, the speed and mileage units stops flashing. Hold  button (**SW**) shortly again, and the meter will enter into the maximum riding speed interface again, or hold  button (**SW**) long for about 2 seconds to save the current set values and exit the general project setting environment and return to display interface.

### ○ Exit General Project Setting

Among the three general project settings, after each setting is completed, if hold  button (**SW**) long for about 2 seconds, all can exit the setting environment and return to display interface, meanwhile, the current set parameters are saved.



Under each setting interface, if there's no button operation on the meter for more than 1 minute, and then the meter will automatically return to display interface, and the original set parameters will be saved.

## P Parameter Setting

After finishing metric/imperial unit settings, the speed and mileage units stop flashing. Within one minute after stopping flashing, hold  button (**UP**) and  button (**DOWN**) simultaneously for about 2 seconds to enter P parameter setting environment.

### ○ P1 Motor Characteristic Parameter Setting Mode

P1 is motor characteristic parameter setting mode.  $P1 = \text{motor gear reduction ratio} \times \text{number of rotor magnet pieces}$ , just rounding if there's any decimal.

After entering P parameter setting environment, the first is to set P1 parameter, P1 parameter column flashes. P1 setting ranges between 1-255, hold  button (**UP**) or  button (**DOWN**) shortly for selection.

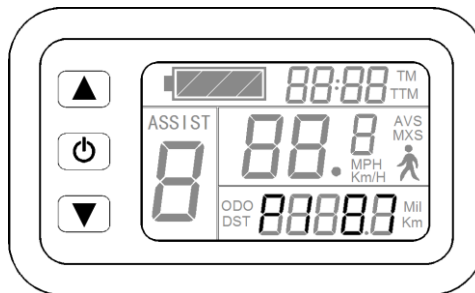

P1 parameter setting interface

**Under P1 parameter setting interface, if there's no button operation on the meter for more than 1 minute, and then the meter will automatically return to display interface, and the original set parameter will be saved.**



After finishing P1 parameter setting, hold  button (**SW**) shortly to enter P2 parameter setting interface.

### ○ P2 Wheel Speed Pulse Signal Setting Mode

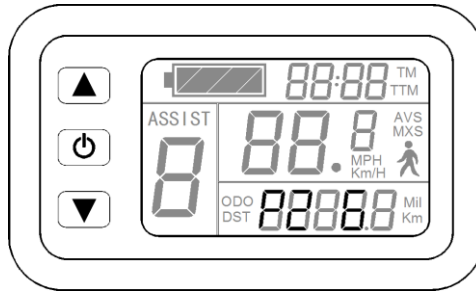
Enter P2 parameter setting interface after P1 parameter setting is finished, and P2 parameter column flashes.



P2 parameter setting interface

P2 is wheel speed pulse signal setting mode. If wheel generated 1 pulse signal by a revolution, P2 should be set as 1. If wheel generated 6 pulse signals by a revolution, P2 should be set as 6. If users didn't configure the pulse signal system, and then P2 parameter setting can be 0. The setting range of P2 should be between 0-6, hold  button (**UP**) shortly or  button (**DOWN**) for selection.

**Under P2 parameter setting interface, if there's no button operation on the meter for more than 1 minute, and then the meter will automatically return to display interface, and the original set parameter will be saved.**

After finishing P2 parameter setting, hold  button (**SW**) shortly to enter P3 parameter setting interface.

**Please Note:** when P2 parameter is set to be 0, for the built-in clutch motor, there will be the following defects, when the internal motor rotors stop or the internal rotor speed is lower than the outer rotor speed, then the speed displayed on the meter is inaccurate!

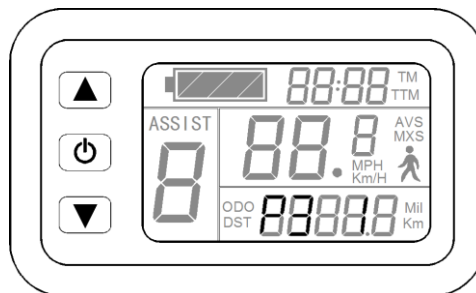

#### ○ P3 Power Assist Control Mode

Enter P3 parameter setting interface after P2 parameter setting is finished, and P3 parameter column flashes.



P3 parameter setting interface

P3 is for power assist control mode, when P3 parameter setting is 1, power assist



control mode is gear 5 of "**imitation torque control**" mode, when P3 parameter setting is 0, power assist control mode is gear 5 of "**speed control**" mode. P3 parameter needs to be determined according to the distributed function of the controller, its setting range is 0 or 1, hold  button (**UP**) shortly or  button (**DOWN**) for selection. P3 parameter setting method is the same to that of P2.

#### ○ P4 Handlebar Startup Mode

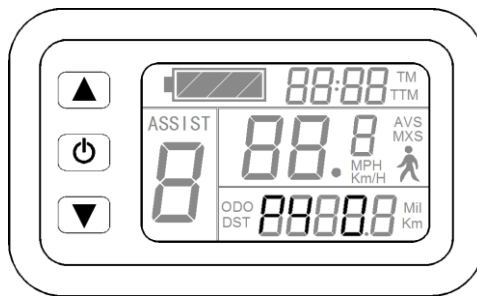
Enter P4 parameter setting interface after P3 parameter setting is finished, P4 parameter column flashes.



P4 parameter setting interface

P4 is handlebar startup mode. When P4 setting is 1, indicating the handlebar is under "**non-zero startup**" mode, namely, the handlebar can be effective only after startup the foot power assist. When P4 setting is 0, indicating the handlebar is under "**zero startup**" mode, the motor can be startup by the handlebar directly. P4 setting range is 0 or 1, hold  button (**UP**) or  button (**DOWN**) shortly for selection. P4 parameter setting method is the same to that of P2.



#### ○ P5 Power Monitoring Mode

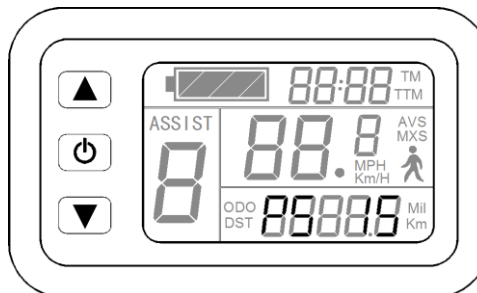

Enter P5 parameter setting interface after P4 parameter setting is finished, P5 parameter column flashes.



P5 parameter setting interface



P5 is power monitoring mode, when P5 setting is 0, the power monitoring is the "real-time voltage" mode. Namely, it is the method to determine the battery capacity based on real-time battery voltage. When P5 equals to a specified parameter, the power monitoring is the "smart power" mode (this parameter is determined by the battery characteristics, ordinary 24V lithium is generally is 4-11, 36V lithium is between 5\_15). P5 setting ranges from 0-40, hold  button (UP) or  button (DOWN) shortly for selection. P 5 parameter setting method is the same to that of P2.

After finishing P5 parameter setting, hold  button (SW) shortly, P5 parameter column stops flashing. Hold  button (SW) shortly again, the meter re-enter P1 parameter setting interface. Or hold  button (SW) long for about 2 seconds to save current set the values and exit P parameter setting environment and return to the display interface.

#### ○ Exit P Parameter Setting

Among the five P parameter settings, when each parameter setting is completed, if held  button (SW) long for about 2 seconds, all can exit the setting environment and return to display interface, meanwhile, the current set parameters would be saved.

Under each parameter setting interface, if there's no button operation on the meter for more than 1 minute, and then the meter will automatically return to display interface, and the original set parameters will be saved.

#### User Setting Note

After entering the user setting environment, if there's no button operation on the data for more than 1 minute, the meter will automatically return to display interface, and the new set parameters won't be saved.

The factory parameter set value and the default value of the meter can be set according to user requirements.

#### Version Information

KT\_LCD\_V2.5

Released on April 8, 2013